



LET'S BUILD A BETTER FUTURE

 FRONT ENTRY / **AG** series



Comfort is just a step away

Front entry doors, aren't they one of the most important parts of our home? They protect us from the cold, from the rain or the burglars, to mention just these examples. Doors also keeps us away from street noise. But how do you make the right choice, and buy a door that will meet our expectations and serve us for years? An issue that requires careful consideration

before the purchase is the heat transfer coefficient (U). The lower its value, the more heat will stay with us inside. Aluprof offers panelled doors with the U_D coefficient of $0.44 \text{ W}/(\text{m}^2\text{K})$.

When choosing our door, let's not forget to check out their water resistance. It's the water resistance of the door that will keep the driving rain outside in times of strong winds and heavy rain. Water resistance of the front entry door is rated from 3A to 9A. The higher the class, the better the door protects our home. Aluprof offers panelled doors rated 7A.

Infill panels are included in door leaves based on the MB-70, MB-70HI, MB-86 & MB-104 Passive system, and come in a variety of colours and structures. The elements can be milled, decorated with inlays or made of insulated glass. Panelled doors can be fabricated very large and high – up to 1.40 m (W) and almost 2.60 m (H). If, therefore, we dream of an impressive front entrance, this will be the perfect choice. But above all, the door should fit to the style of your home. If our interiors are the traditional ones, we should opt for a leaf with glass panels or wooden-like veneer. Lovers of modern interior can choose among RAL colours, think shade of graphite.

Let's take some time and choose a door with which we will create a beautiful entrance that will enchant our guests and will make us feel like we were in a safe haven.

MB-104 Passive

U_D from 0.44 W/m²K

Aluprof's panel door uses thermally insulated aluminium profile system – MB-104 Passive is the most technologically advanced door system offered by Aluprof. The leaf profile can be combined with special infills, aligned with the surface of the frame. The system is dedicated to passive and energy-efficient buildings.

Elegant decorative panels, available in many different patterns and RAL colours and wood effect finishes

Joint membrane

Expansion profiles

Design variants: SI, SI+ and AERO

Central gaskets around the leaf and the frame to seal, cover, and increase the thermal insulation of the door

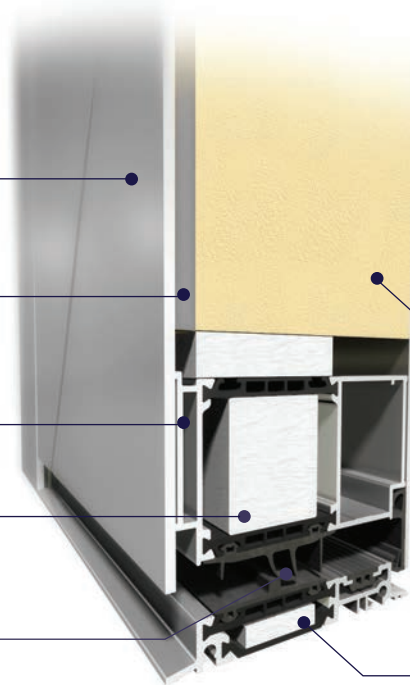

Technical details:

Frame depth	95 mm
Leaf depth	95 mm
Infill panel thickness	44 - 95 mm
Maximum dimensions of the leaf	(HxL) L up to 1400 mm, H up to 2600 mm

Technical parameters:

Air permeability	Class 3, PN-EN 12207:2001
Water tightness	Class E1200 (1200 Pa), PN-EN 12208:2001
Wind load resistance	Class C4/B4, PN-EN 12210:2001
Thermal insulation	U_D from 0,44 W/m ² K
Burglary-resistance	RC2

XPS extruded polystyrene with enhanced thermal insulation

95 mm-wide warm threshold -the same width as the threshold and frame

MB-86

U_D from 0.66 W/m²K

Aluprof's panel doors use thermally insulated aluminium profile system – MB-86 – which, just like the MB-104 Passive system, is dedicated to energy-efficient and passive building. The leaf profile can be combined with special infills, aligned with the surface of the frame.

Technical details:

Frame depth	77 mm
Leaf depth	77 mm
Infill panel thickness	44 - 77 mm
Maximum dimensions of the leaf	(H x L) L up to 1400 mm, H up to 2600 mm

Technical parameters:

Air permeability	Class 3, PN-EN 12207:2001
Water tightness	Class E900 (900 Pa), PN-EN 12208:2001
Wind load resistance	Class C5/B5, PN-EN 12210:2001
Thermal insulation	U_D from 0.66 W/m ² K
Burglary-resistance	RC2

Elegant decorative panels, available in many different patterns and RAL colours and wood effect finishes

Joint membrane

Expansion profiles

They come in four versions: ST, SI, SI+ and AERO for a very good thermal performance

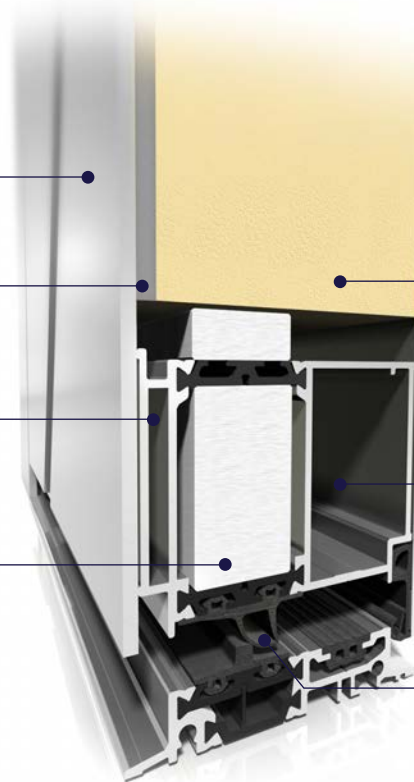

XPS polyurethane foam ensures an excellent thermal insulation

Rigid and durable aluminium profiles permit the fabrication of large dimensioned doors

Specially designed weather strips provide high water tightness and low air permeability, bringing both a comfort and a potential for cost savings

MB-70

U_D from 0.9 W/m²K

The structure of panel doors is based on the popular thermally broken aluminium sections MB-70 and MB-70HI which complete the range of energy-efficient doors in the Aluprof portfolio. Similarly to other panel door system the leaf profile is designed for coupling with special infill panels that can be installed flush with the door frame plane.

Elegant decorative panels, available in many different patterns and RAL colours and wood effect finishes

Joint membrane

Expansion profiles

Two design variants: MB-70 and MB-70HI for a very good thermal performance

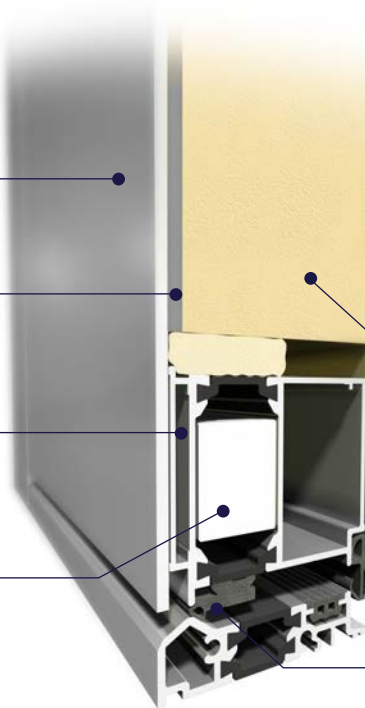

Technical details:

Frame depth	70 mm
Leaf depth	70 mm
Infill panel thickness	44 -70 mm
Maximum dimensions of the leaf	(H x L) L up to 1200 mm, H up to 2400 mm

Technical parameters:

Air permeability	Class 4, PN-EN 12207:2001
Water tightness	Class 7A (300 Pa), PN-EN 12208:2001
Wind load resistance	Class C5/B5, PN-EN 12210:2001
Thermal insulation	U_D from 0.9 W/m ² K
Burglary-resistance	RC2

XPS extruded polystyrene with enhanced thermal insulation

Specially designed weather strips provide high water tightness and low air permeability, bringing both a comfort and a potential for cost savings



BASIC



Insert panels

- Triple glazing units, U_g coefficient of U_g 0.5 W/m²K or of 0.7 W/m²K
- 44 and 52 mm thick panels
- Thermal transmittance for MB-70HI doors U_D from 1.3 W/m²K, for MB-86 doors U_D from 0.8 W/m²K, and for MB-104 doors U_D from 0.63 W/m²K
- Product variants: ST, HI, SI, SI+ and Aero

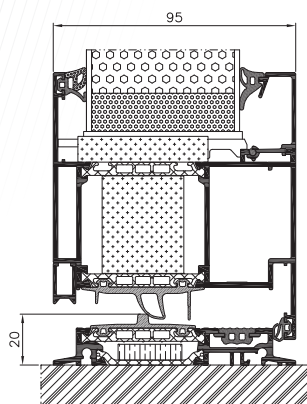

CLASSIC



Aligned on one side

- Triple and quadruple glazing units, U_g coefficient of U_g 0.5 W/m²K or of 0.7 W/m²K
- 44 and 65 mm thick panels
- Thermal transmittance for MB-70HI doors U_D from 1.10 W/m²K, for MB-86 doors U_D from 0.64 W/m²K, and for MB-104 doors U_D from 0.48 W/m²K
- Product variants: ST, HI, SI, SI+ and Aero

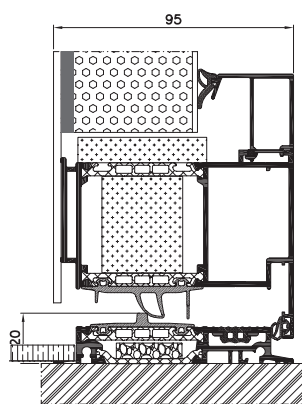

EXCLUSIVE



Aligned on both sides

- Quadruple glazing units, U_g coefficient of U_g 0.5 W/m²K or of 0.7 W/m²K
- 70 mm thick panel (MB-70 and MB-70HI), 77 mm (MB-86) and 95 mm (MB-104 Passive)
- Thermal transmittance for MB-70HI doors U_D from 0.9 W/m²K, for MB-86 doors U_D from 0.63 W/m²K, and for MB-104 doors U_D from 0.44 W/m²K
- Product variants: ST, HI, SI, SI+ and Aero

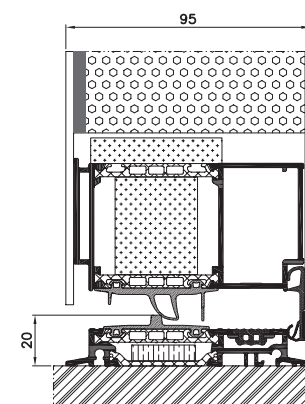

All available models can be inserted into the profiles or glued on one or both sides.

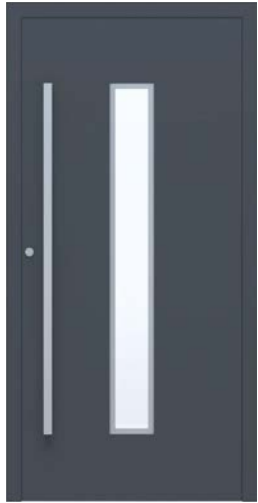

AG01
page 10



AG01B
page 10



AG02
page 10



AG02B
page 11

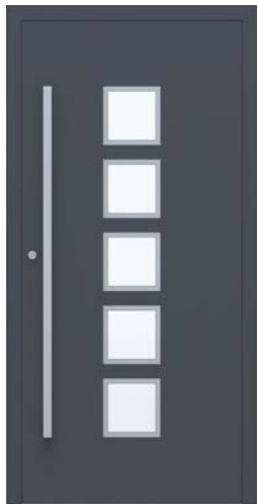

AG03
page 12

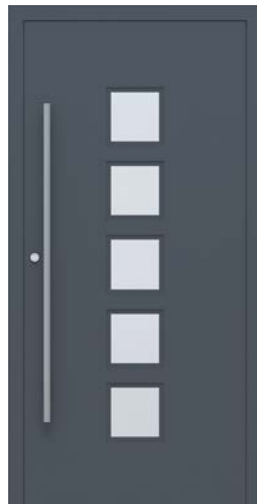

AG03B
page 12



AG04
page 12



AG04B
page 13



AG05
page 14



AG05B
page 14



AG06
page 14



AG07
page 15

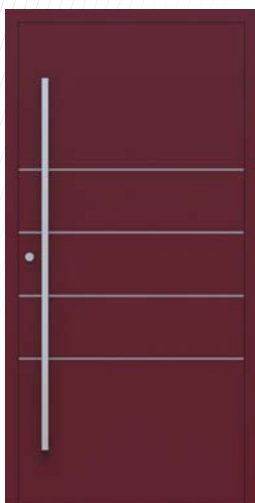

AG08
page 16



AG08B
page 16



AG09
page 16



AG010
page 17



AG01

- AQ 10 1600 door pull handle made of high-grade steel
- Glazing (front): VSG 33.1
- Glazing (center): sandblasted glass
- Inlay: flush inox inlay
- Colour: RAL 7016



AG01B

- AS 10 1400 door pull handle made of high-grade steel
- Glazing (front): VSG 33.1
- Glazing (center): sandblasted glass
- Inlay: milled
- Colour: RAL 9007



AG02

- AQ 10 1200 door pull handle made of high-grade steel
- Glazing (front): VSG 33.1
- Glazing (center): sandblasted glass with transparent strips
- Inlay: flush inox inlay
- Colour: RAL 7016



AG02B

- AS 10 1200 door pull handle made of high-grade steel
- Glazing (front): VSG 33.1
- Glazing (center): sandblasted glass with transparent strips
- Inlay: milled
- Colour: RAL 9007





AG03

- AQ 10 1600 door pull handle made of high-grade steel
- Glazing (front): VSG 33.1
- Glazing (center): sandblasted glass
- Inlay: flush inox inlay
- Colour: RAL 7016

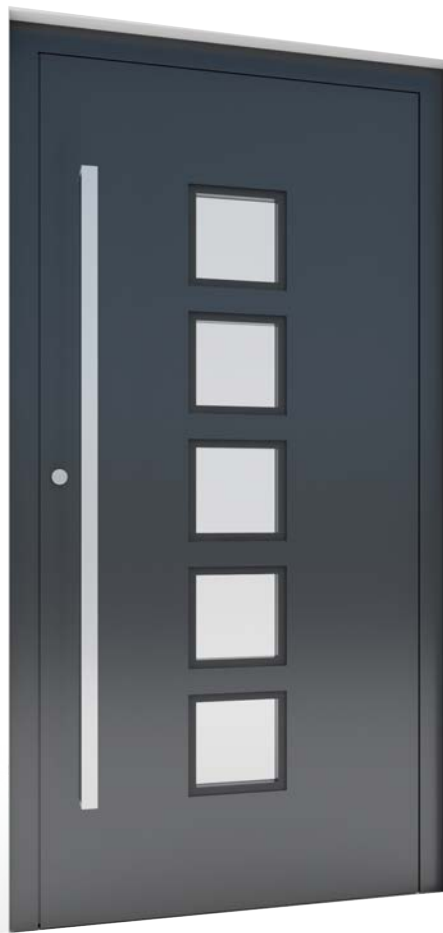

AG03B

- AQ 10 1600 door pull handle made of high-grade steel
- Glazing (front): VSG 33.1
- Glazing (center): sandblasted glass
- Inlay: milled
- Colour: RAL DB703



AG04

- AQ 10 1200 door pull handle made of high-grade steel
- Glazing (front): VSG 33.1
- Glazing (center): sandblasted glass with transparent strips
- Inlay: flush inox inlay
- Colour: RAL 7016



AG04B

- AS 10 1200 door pull handle made of high-grade steel
- Glazing (front): VSG 33.1
- Glazing (center): sandblasted glass with transparent strips
- Inlay: milled
- Colour: RAL 9007





AG05

- AQ 10 1600 door pull handle made of high-grade steel
- Inlay: flush inox inlay
- Colour: RAL 7016



AG05B

- AW 10 door pull handle made of high-grade steel
- Inlay: milled
- Colour: RAL 9007



AG06

- AS 10 800 door pull handle made of highgrade steel
- Glazing (front): VSG 33.1
- Glazing (center): sandblasted glass with transparent strips
- Colour: RAL 7001



AG07

- Door pull handle, high-grade steel:
AQ 10 1000, RAL 9005
- Inlay: milled
- Colour: ADEC D207 Winchester





AG08

- AQ 10 1600 door pull handle made of high-grade steel
- Inlay: flush inox inlay
- Colour: RAL 3004



AG08B

- AS 10D 1600 door pull handle made of high-grade steel
- Inlay: milled
- Colour: RAL 9007



AG09

- AQ 10 1600 door pull handle made of high-grade steel
- Colour: RAL 9006



AG10

- 1600 flush pull handle in RAL colour of your choice
- Colour: RAL 7016



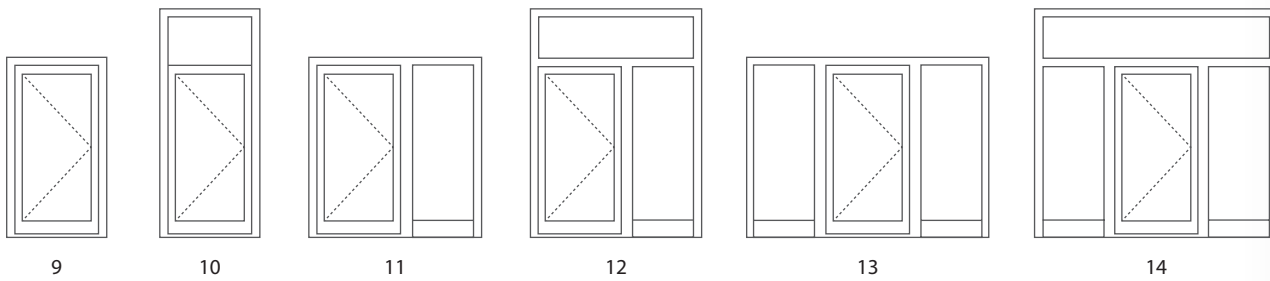
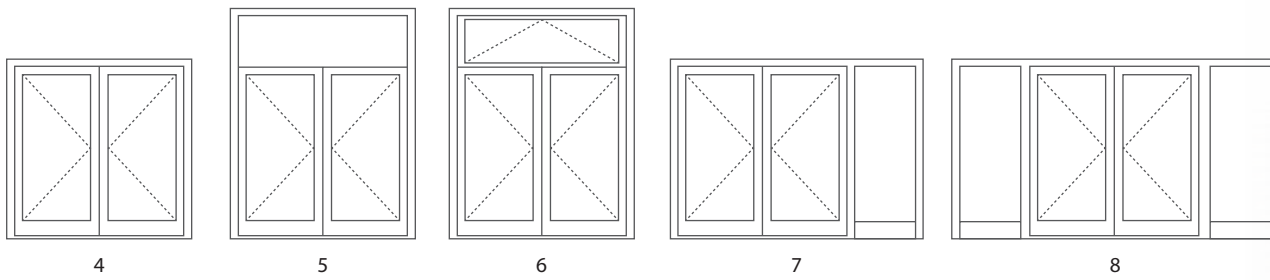
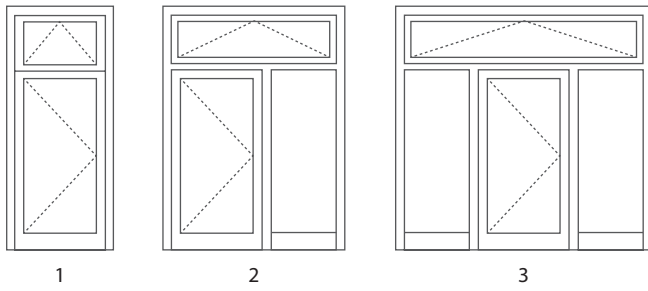

// Pulls*

● stainless steel ● black

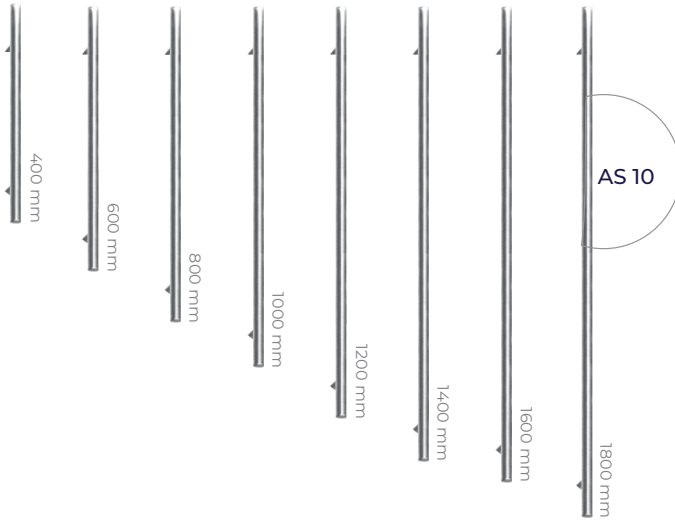

AS 10

available
dia. 30 mm
straight bracket

- AS 10 400
- AS 10 600
- AS 10 800
- AS 10 1000
- AS 10 1200
- AS 10 1400
- AS 10 1600
- AS 10 1800

● stainless steel ● black

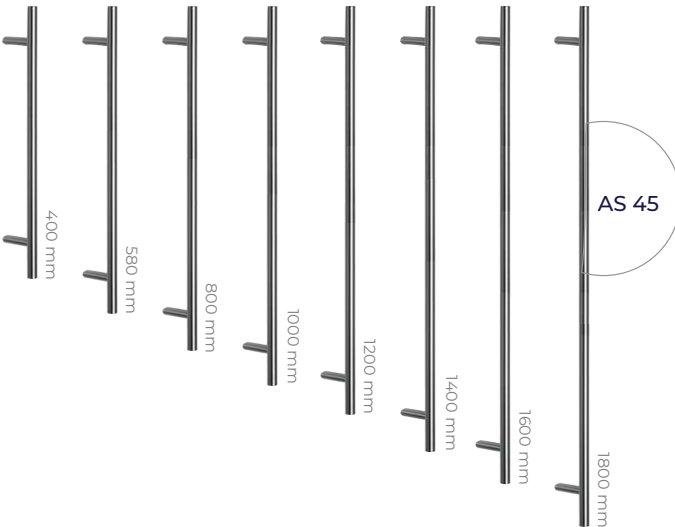

AS 45

available
dia. 30 mm
angle brace 45°

- AS 45 400
- AS 45 580
- AS 45 800
- AS 45 1000
- AS 45 1200
- AS 45 1400
- AS 45 1600
- AS 45 1800

// Pulls*

● stainless steel ● black

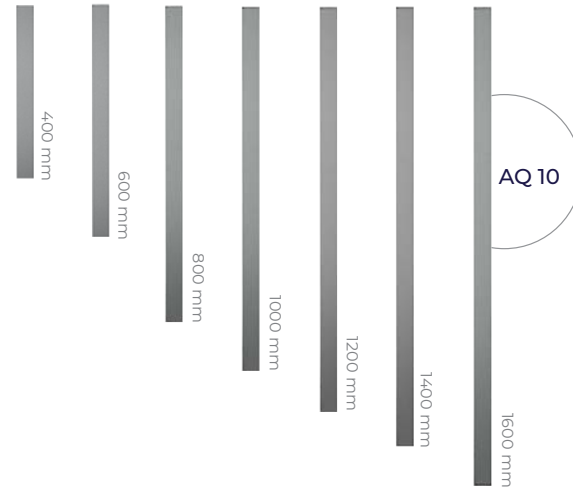

AQ 10

available
40 x 20, 40 x 40 mm
straight bracket

- AQ 1020 400
- AQ 1020 600
- AQ 1020 800
- AQ 1020 1000
- AQ 1020 1200
- AQ 1020 1400
- AQ 1020 1600

- AQ 1040 400
- AQ 1040 600
- AQ 1040 800
- AQ 1040 1000
- AQ 1040 1200
- AQ 1040 1400
- AQ 1040 1600

● stainless steel ● black

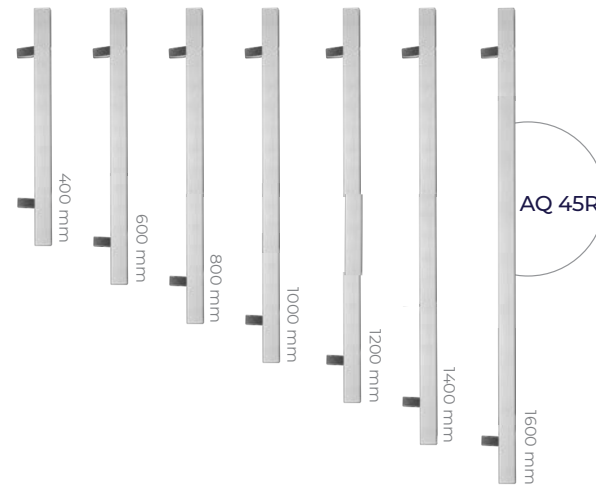

AQ 45R

available
40 x 20, 40 x 40 mm
angle brace 45°

- AQ 4520R 400
- AQ 4520R 600
- AQ 4520R 800
- AQ 4520R 1000
- AQ 4520R 1200
- AQ 4520R 1400
- AQ 4520R 1600

- AQ 4540R 400
- AQ 4540R 600
- AQ 4540R 800
- AQ 4540R 1000
- AQ 4540R 1200
- AQ 4540R 1400
- AQ 4540R 1600

* Mounting kit included - see the price list for details.

// Pulls*



// Flush pull handles

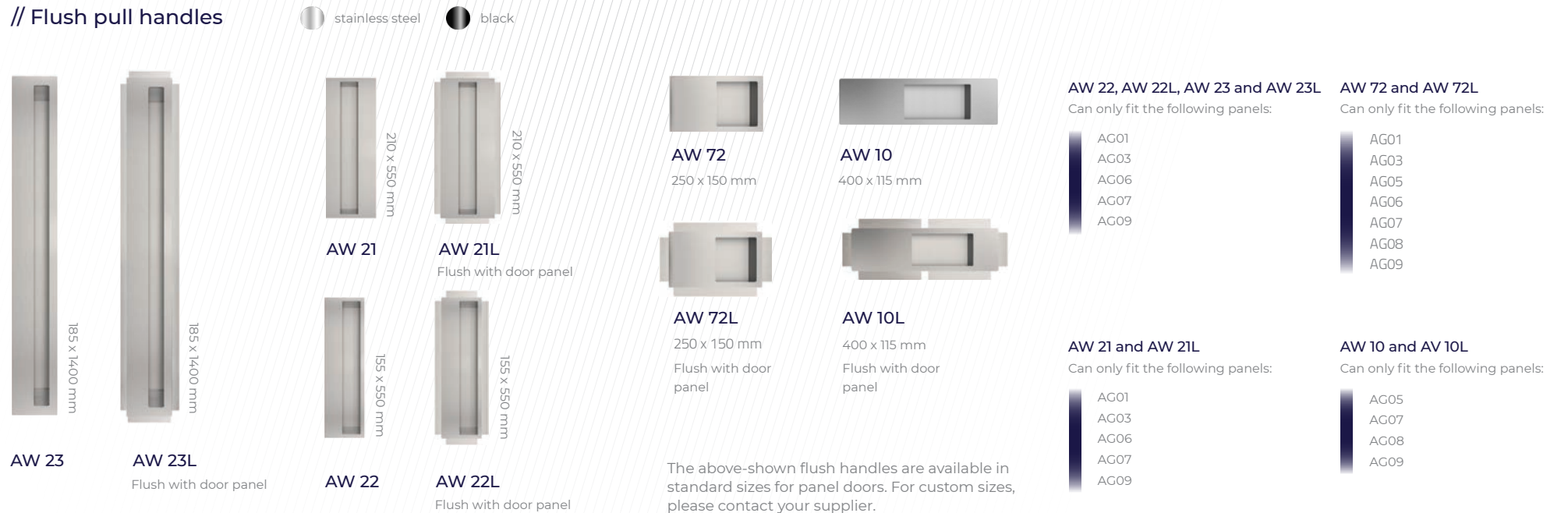

// Lever pull

ALUPROF STYLE

1924216X: stainless steel, natural anode and inox, white, anthracite, black



ALUPROF STYLE

1924218X: stainless steel, natural anode and inox, white, anthracite, black



1924231X: stainless steel, natural anode and inox, white, anthracite, black

ALUPROF LINE

1924220: stainless steel, natural anode and inox, white, anthracite, black



ALUPROF LINE

1924229X: stainless steel, natural anode and inox, white, anthracite, black



1924231X: stainless steel, natural anode and inox, white, anthracite, black

ALUPROF CLASSIC

1924111X: RAL



1924113X: RAL

FAPIM

8001289X: natural anode, RAL



1924113X: RAL

SOBINCO HORIZON

8000997X: natural anode, anode inox, RAL





SOBINCO EDGE

8H00127X: natural anode, anode inox, RAL



// Rosettes

-  stainless steel
-  black

AGR 10



// Scratch protection



AB 01

W 50 x H 100 mm



AB 02

W 50 x H 100 mm



AB 03

W 50 x H 100 mm



AB 04

W 100 x H 50 mm

// Kickplates

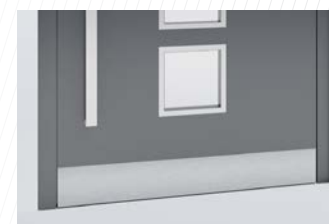

Flush or glued kickplate AK 130

130 mm high

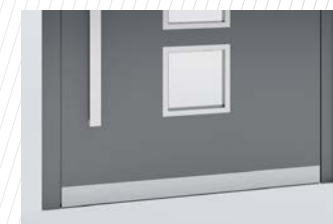

Flush or glued kickplate AK 60

60 mm high

// Ornaments



Master-Point



Satinata



Master-Ligne



Master-Carre

Aluprof offers a wide range of glass with motif, glass made of transparent or ornamental glass in its most popular models.

All door models come in variants with sidelight and toplight.

Variant 1: Sandblasted glass (motif)

Variant 2: Transparent glass

Variant 3: Ornamental glass

Variant 4: Safety glass

Sidelights and fixed lights include triple glazing units with warm glass spacers. Sidelights (fixed glazing) can be placed either on one or on both sides of the door assembly.

Maximum sidelight width: 1400 mm

Ornaments (optional):

“Master-Point”

“Satinata”

“Master-Ligne”

“Master-Carre”

Other ornamental glass available on request.

For details, contact our sales representatives.

// Wood effect / Concrete effect



Golden Oak ADEC D101 Rustic Oak ADEC D210 Swamp Oak ADEC D502 Vintage Oak ADEC D825 Ebony ADEC M102 Palisander ADEC M332 Walnut ADEC O102 Walnut Vein ADEC O205 Dark walnut ADEC O306 Mahogany ADEC M103



Mahogany Sapeli ADEC M204 Pine ADEC S106 Pine ADEC S110 Fir ADEC J107 Fir ADEC S208 Beech ADEC B108 Cherry ADEC W109 Wenge ADEC W205 Winchester ADEC D207 Gean ADEC C110

// RAL & structural colours*



Gean ADEC C212 Dark Cherry ADEC C106 Chestnut ADEC K101 Concrete ADEC E137

* All RAL colours and structural colours as per the offer. The colours may vary slightly from the finished product.



Scan the QR code
and download the PDF
onto your mobile device

ALUPROF

ALUMINIUM SYSTEMS

ALUPROF SA

ul. Warszawska 153, 43-300 Bielsko-Biała, Poland
tel. +48 33 81 95 300, fax +48 33 82 20 512
e-mail: aluprof@aluprof.eu, www.aluprof.eu